



Pole Mount



Plug-in



Form 2S



3-phase

BOOMERANG VOLTAGE, CURRENT AND POWER MONITORS

The Boomerang family of wireless power monitors extends your SCADA system to anywhere needed: a voltage regulator on a pole, the end of a distribution line, even a 120V receptacle. Every Boomerang includes an integrated cell modem with internal antenna for unobtrusive real-time voltage, current, and power monitoring from anywhere.

120V PLUG-IN

The world's first 120V receptacle SCADA voltage, current, and power sensor! The plug-in form factor is perfect for spot checks at troublesome locations, and for recloser and outage monitoring and notification. The integrated antenna and cell modem is much less intrusive than older, dial-up telephone plug-in monitors.

FORM 2S METER SOCKET

Standard pass-through Form 2S meter socket adapter, for single-phase applications. With no external antenna or ports, the low profile and unobtrusive Boomerang is perfect for residential locations, giving readings right at the point of common coupling.

3-PHASE STANDALONE

Pocket-sized, weatherproof form factor for 3-phase monitoring anywhere. The small size gives maximum flexibility for monitoring in almost any location.



CANVASS™

WEB-BASED DATA PORTAL

FREE LIVE DEMONSTRATION:

Log in anytime to view and interact with live data from demonstration units in the field.

Registering for a **FREE** demo account is simple. Visit: canvass.powermonitors.com/util/register.jsp.

Once registered, login at: canvass.powermonitors.com

GET ON THE MAP

We have demonstration units available for loan. If you'd like to get on the map and find out first hand how the BOOMERANG and Canvass can work for you, contact your PMI equipment rep:

Contact Us:
800.296.4120
sales@powermonitors.com
www.powermonitors.com

POLE MOUNT

Single-phase or 3-phase Boomerang for power pole applications such as voltage regulator or capacitor bank measurements, or end of line monitoring. Rugged NEMA 4X enclosure includes terminal block and mounting feet for permanent installations.



Pole Mount

		120V PLUG-IN	FORM 2S	3 PHASE	POLE-MOUNT
VOLTAGE	Input range	80-140V RMS	80-300V RMS	80-300V RMS (600V with PoE)	80-300V RMS
	Accuracy	0.50%	0.50%	0.50%	0.50%
	Resolution	0.1V	0.1V	0.1V	0.1V
CURRENT	Measured Quantities	0-40A (15A continuous)	0-400A RMS total (200A per leg)	20, 200A w/ TLARS 100, 1000, 5000A w/ FCTs	20, 200A w/ TLARS 100, 1000, 5000A w/ FCTs
	Accuracy	1%	1%	1%	1%
POWER	Accuracy	1%	1%	1%	1%
COMMUNICATION	Standard	GSM or CDMA cell modem	GSM or CDMA cell modem	GSM or CDMA cell modem	GSM or CDMA cell modem
	Options	-	-	10/100 Ethernet, PoE (optional)	-
ENVIRONMENTAL	Temperature Range	Indoor Use Only	-22F to 130F	-22F to 130F	-22F to 130F
PHYSICAL DIMENSIONS	Size	4.9"L x 2.7"W x 1.25"H	6.75"W x 4.625"H	4.8"L x 3.35"W x 1.84"H	6.5"L x 6.5"W x 4.25"H
	Weight	0.5 lbs	3.6 lbs	less than 1 lb	3.6 lbs
	Case	-	NEMA 4X	NEMA 4X	NEMA 4X

BOOMERANG VOLTAGE, CURRENT AND POWER MONITORS

REAL-TIME DEMAND MANAGEMENT

A full-featured DNP3 interface is optimized for Demand Management and Conservation Voltage Reduction systems, including multiple configurable voltage thresholds, unsolicited report by exception and polled modes, and analog and binary points. Fine-tuned for use with low-cost telemetry data plans, the Boomerang DNP3 interface gives your SCADA system the true real-time data required for CVR systems, and ensures that regulatory limits are still being met.

FEATURES:

- Full DNP3 interface through TCP or UDP cellular connection to SCADA systems
- Optimized for low cost telemetry data plans
- Low profile, unobtrusive form factors for any location
- Configurable voltage thresholds, user-defined settings
- Instant e-mail and SMS text alerts
- Flexible unsolicited report by exception triggers to work with any CVR/DMS system
- Analog DNP3 points for all measured quantities and modem signal strength

BOOMERANG AS AN OUTSTATION

The Boomerang voltage monitor has been designed with the capability to be a DNP3 outstation for a SCADA system. An outstation can collect various types of data for the SCADA system to utilize. It can also receive data from the master for settings such as thresholds, timing or scale factors. This data is arranged by object type and points within each type that details the specific pieces of data. For more on the object types and various points available with the Boomerang, click [HERE](#) to download the white paper: *An Overview of DNP3 and Boomerang Point Map*.

In addition to a full DNP3 interface, Boomerang voltage monitors interface with Canvass, PMI's web-based database and data analysis package. With Canvass, the user can view voltage stripcharts, histograms and daily profile graphs for every data point that the device has ever registered to the PMI Canvass data warehouse. All historical voltage data is available in a web browser, accessible through powerful graphs and reports.

CONSERVATION VOLTAGE REDUCTION WITH THE BOOMERANG

The Boomerang is designed to work with any CVR system, providing accurate voltage telemetry and triggering in realtime via an embedded, wireless, cellular data connection. Conservation Voltage Reduction (CVR) is a method for lowering peak energy demand by lowering the average system voltage during the peak periods. The CVR concept is to tightly regulate the voltage delivered to customers, and to keep that voltage close to the regulatory minimum level. This greatly reduces

the margin for voltage variations in the distribution system, and requires real-time measurement and control to adjust equipment in response to load shifts over time. A key decision is where to monitor for residential locations— at the meter base or transformer secondary? Advantages for the meter base are that the service voltage drop is included, and this is the point where the regulatory minimum voltage applies. Advantages for the transformer secondary are that installation is less disruptive (no outage to the customer), and voltage readings are more representative of distribution voltage. The Boomerang is available in meter base and pole-mounted versions (and even a 120V plug-in version), so the choice should be based on system model requirements and measurement goals. For more on CVR, be sure to download the white paper *Conservation Voltage Reduction with the Boomerang*, available [HERE](#).

E-MAIL NOTIFICATION

Canvass provides e-mail notification based on programmable events and alarms. This system provides real-time, on-the-spot notifications from devices in the field through e-mail (on a desktop, on a laptop or any mobile device), 24 hours a day, 7 days a week, all through a simple and intuitive online configuration. For more on the Canvass e-mail notification system click [HERE](#) to download the white paper: *E-mail Alerts in Canvass*

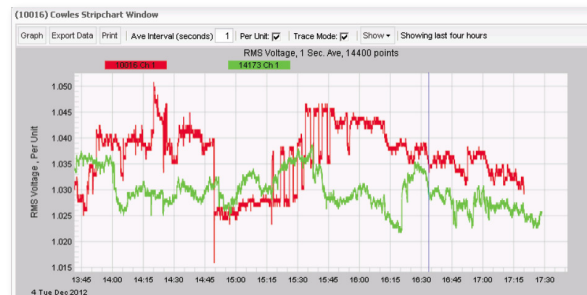

POWERFUL GRAPHS AND REPORTS

Canvass includes support for printing and exporting graph data to a CSV file, even with multiple monitors selected at once, and a point trace table. To find out more about reporting features in Canvass, click [HERE](#) to download the white paper: *New Additions to the Canvass Interface*.

CHOOSING A CELL PLAN

Boomerangs can be provisioned on either a GSM or a CDMA wireless network. Different plans are available to suite the variety of Boomerang configurations available. However, users are not limited to using Power Monitors' tiered pricing plan. To find out more, download the white paper *Choosing a Cell Plan for Boomerangs* by clicking [HERE](#) or contact your PMI equipment representative at 800.296.4120.

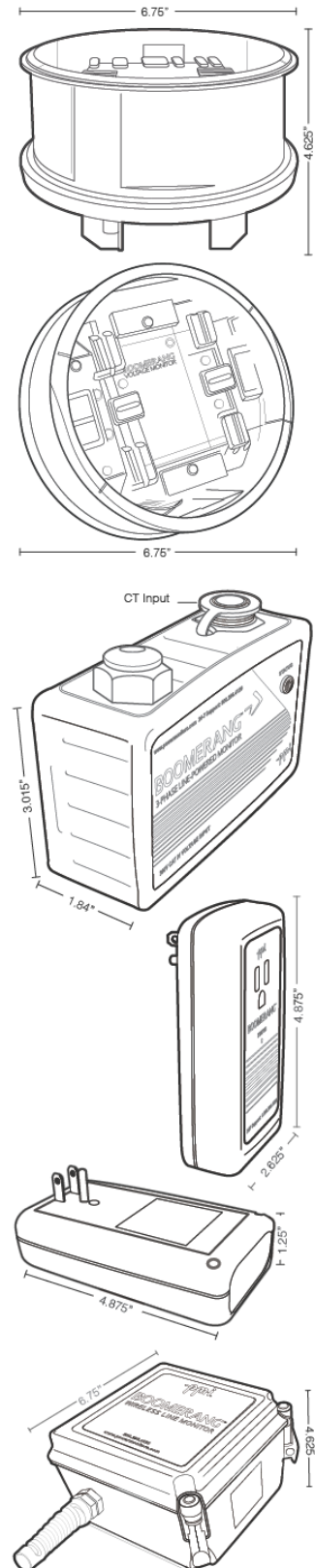

When used with the CANVASS cloud system, the Revolution and Boomerang collect data on a regular basis. Every 30 minutes the most recent values are sent to the PMI data center. With this system, all data collection is performed continuously; NO data is stored in the device, and NO recording download operation is required by the user.

Fine-tune your CVR system by using Canvass to analyze voltage trends and regulator responses over geographic regions. Canvass can also be configured to send e-mail and text messages based on real-time events, for immediate action outside your SCADA system.

FEATURES

- Get real-time readings in the status window
- One-second values and user-defined averages
- View status information such as modem signal strength, and total cell network traffic.
- The menus in the status window are used for graphing and device setup.
- Send e-mail or SMS text message alerts, based on programmable thresholds, or power outages. These alerts are also stored in the Canvass database, for analysis later.
- Full zoom control
- Compare voltage, current and power from different locations, and find correlations across a distribution system.
- Graph multiple devices as overlays on a single graph
- 3 graph types: Stripchart, Histogram, and Daily Profile
- Graph options feature many adjustable settings such as timespan, per unit values, x-axis scale, averaging interval, etc.
- Administrator access allows you to easily manage user accounts and preferences, setup distribution lists, and configure devices.

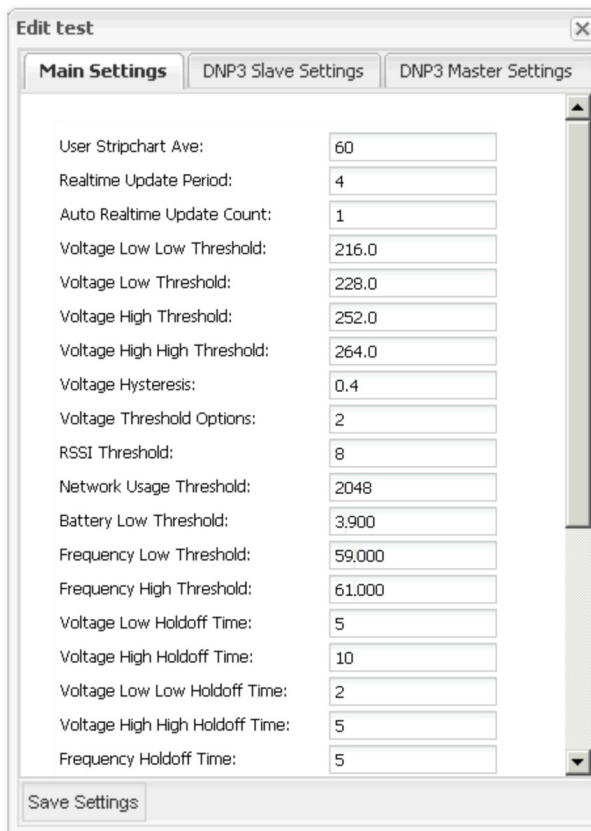

The Canvass DNP3 interface features multiple configurable voltage thresholds, unsolicited report by exception and polled modes, and analog and binary points.

FREE LIVE DEMONSTRATION:

Log in anytime to view and interact with live data from demonstration units in the field.

Registering for a demo account is simple; click [HERE](#). Once your registration has been confirmed, log in at: canvass.powermonitors.com

GET ON THE MAP

We have demonstration units available for loan. If you'd like to get on the map and find out first hand how Canvass can work for you, contact your PMI equipment rep:

Contact Us:
800.296.4120
sales@powermonitors.com
www.powermonitors.com

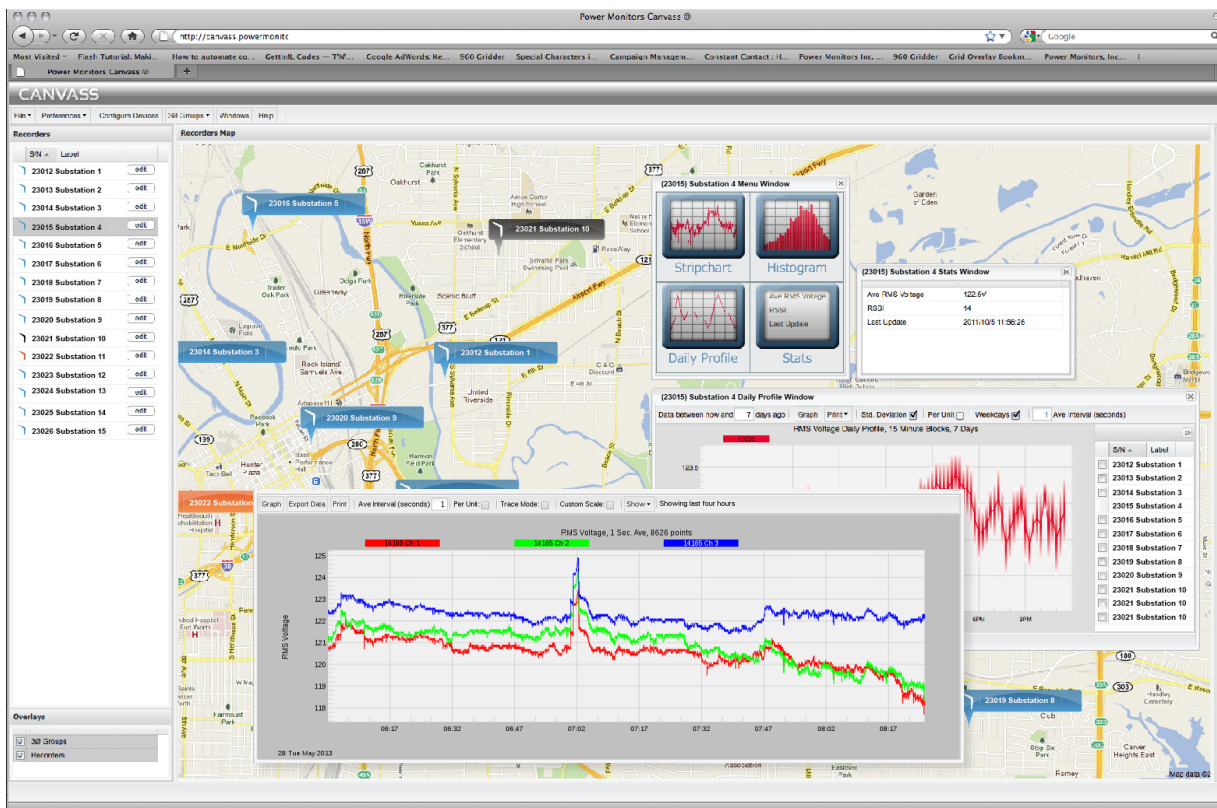

Canvass shows the latest real-time readings and stats from each Boomerang in an intuitive user interface

FREE LIVE DEMONSTRATION:

Log in anytime to view and interact with live data from demonstration units in the field.

Registering for a demo account is simple; click [HERE](#). Once your registration has been confirmed, log in at: canvass.powermonitors.com

GET ON THE MAP

We have demonstration units available for loan. If you'd like to get on the map and find out first hand how Canvass can work for you, contact your PMI equipment rep:

Contact Us:
800.296.4120
sales@powermonitors.com
www.powermonitors.com

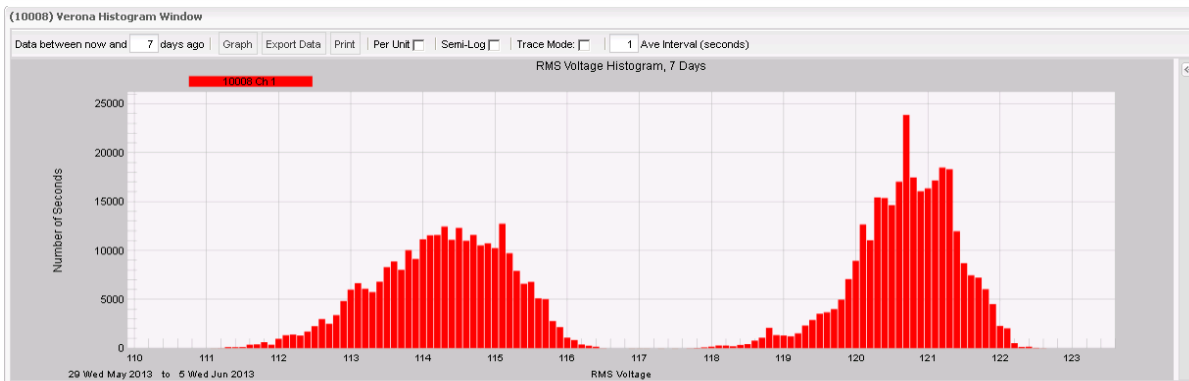
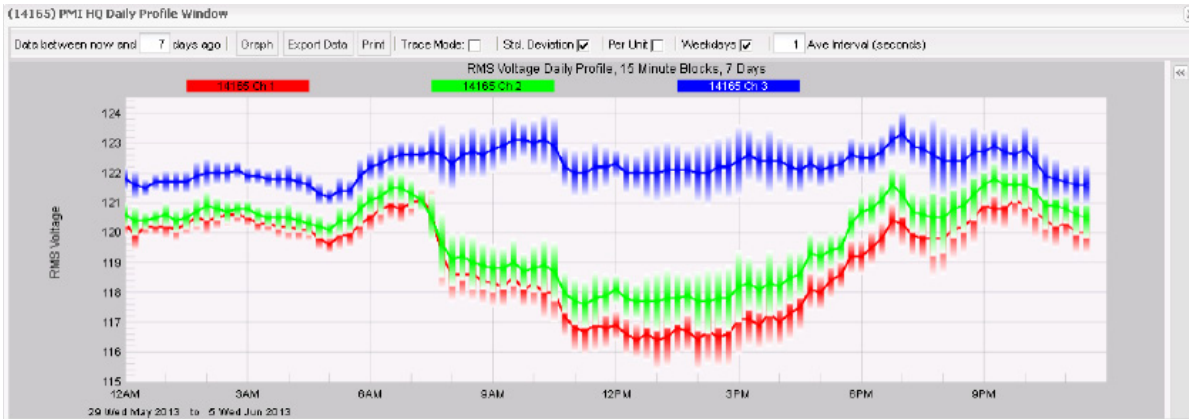
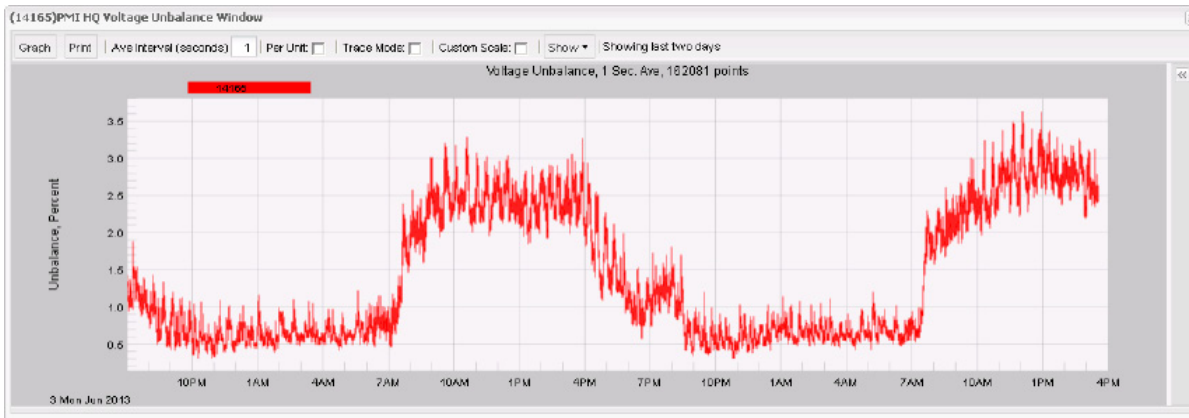

STRIPCHART

The default stripchart graphs the last four hours of data, using 1 second values. The stripchart start and stop times can be changed to several built-in values (e.g. the last week, last month, etc.) or adjusted to any custom date range. These graphs can include all data ever recorded – there's no limit to the size of the graph; since data is continuously being sent to the database, there are no gaps in the data, or start or stop times in a recording.

DAILY PROFILE GRAPH

Particularly useful for monitoring voltage regulation, Canvass Daily Profiles graphs are a great tool for spotting issues with both short and long term voltage trends. The Daily Profile graph show the “average” 24 hour period, for the selected timestamp. The user specifies a time frame of a single day or even up to several months and Canvass returns a graph of the “average day” over the duration of the specified time frame.

The Daily Profile graph has several adjustable parameters: Time Span, Standard Deviation, Per Unit, Weekdays Only and Averaging Interval.

Daily Profiles are an average of the RMS voltage, current and power over the specified averaging interval for each day in the specified timespan. Graph standard deviation to display the specific variance throughout a specified time span for a particular time point.

HISTOGRAM

The Canvass Histogram graph is a powerful tool to characterize the probability distribution of voltage at a particular location. The shape of the graph, coupled with the statistical analysis, can reveal patterns in the service voltage, and also help quantify a level of service on a statistical basis.

For additional documentation on CANVASS click [HERE](#).